

We know bike parking. Inside and out.®



DERO
A PLAYCORE Company



**BEN
SHAFFER
RECREATION**

973-663-2021

www.benshaffer.com





TABLE OF CONTENTS

4 BIKE RACKS

STANDARD RACKS

- 4 Bike Hitch
- 5 Hoop Rack
Hoop Rack Heavy Duty
Swerve Rack
- 6 Round Rack
Arc Rack
Downtown Rack
- 7 Cycle Dock™
Bike Bike Rack
- 8 Recycle Racks
Helix Rack
Campus Rack
- 9 Rolling Rack
Hi Roller

VERTICAL PARKING

- 12 Ultra Space Saver Squared
Ultra Space Saver
- 13 Ultra Space Saver Single
Bike File
Track Rack

2-TIER PARKING

- 15 Dero Decker
Dero Duplex

CUSTOM BIKE RACKS

- 16 Full Custom Designs
- 17 Logo Racks
Image Infusion
Icon Hitch™
Type Rider™ Racks

STREETSCAPES

- 19 Cycle Stall Elite
Cycle Stall Basic
- 20 Dero Parklet
Biker Bar™

SPECIALTY BIKE RACKS

- 22 Event Rack
Compact Rack
U-Lockit™
- 23 Alley Rack™
Switchback™
Saddle Buddy™
Wall Rack
Meter Hitch
Bike Hook Solo
Lock Dock

24 PUBLIC BIKE REPAIR

- 25 Fixit
- 26 Air Kit 2
Air Kit 3
Tool Kit
Pump Stop

28 BIKE LOCKERS

- 28 Dero Vertical Locker
- 29 Dero Two-Tier Locker
Veloport™
Dero Single Locker™
Dero Double Locker™
Fiberglass Lockers

30 BIKE SHELTERS

- 31 Bike Depot
Vizor™ Shelter
Cycle Station
- 32 Stratus Shelter™
Pocket Shelter
- 33 Kolo Shelter

34 PRODUCT OPTIONS

35 DERO ZAP

35 SITE AMENITIES



HELPFUL HINTS

Watch for the lightbulb icon throughout this catalog for a series of tips and useful information to help you plan your bike parking project.

For more resources and a more complete, downloadable bike parking guide visit our website – www.dero.com.



Dero products are proudly designed and manufactured in the United States with recycled steel.

BIKE RACKS



BIKE HITCH

2    

Ensures proper parallel alignment of bike and rack. Ideal for sidewalk placement. The full radius bend of the ring makes it difficult to cut with a pipe-cutter.

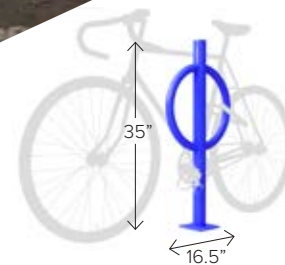

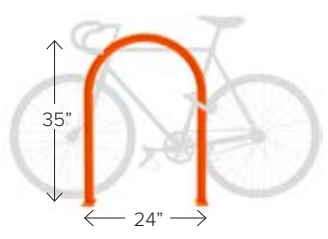

HOOP RACK
2 🚲 □□□□□

High security and easy bike parking. The Hoop Rack uses thick pipe construction.

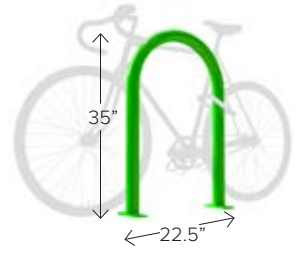

HOOP RACK HEAVY DUTY
2 🚲 □□□□□

The Hoop Rack Heavy Duty uses a larger, thicker pipe than our standard Hoop Rack.

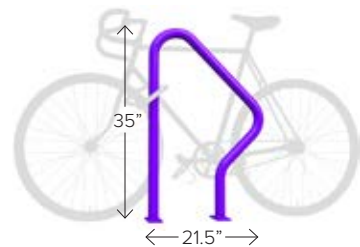

SWERVE RACK
2 🚲 □□□□□

The Swerve Rack supports the bicycle at two points and mimics bike frame angles for easier locking.



CUSTOMIZE YOUR RACK WITH A LASER CUT LOGO!

A custom rack with your logo can increase awareness of your business and show that your company supports clean, healthy forms of transportation.

See [page 17](#) for more info!



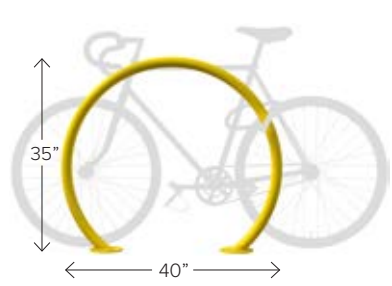

ROUND RACK
2

Clean lines and simple functionality.

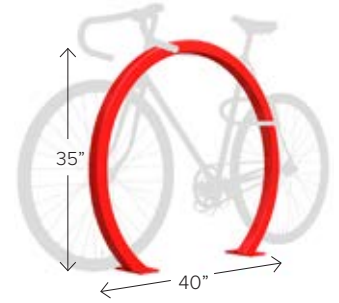

ARC RACK
2

Square tubing provides security and style with clean, geometric lines.

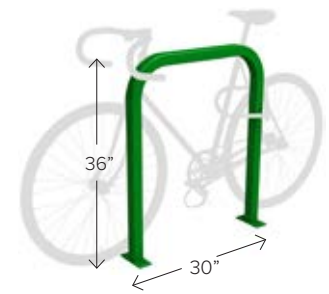

DOWNTOWN RACK
2

Uses thick, square-tube construction that cannot be cut with a pipe cutter.

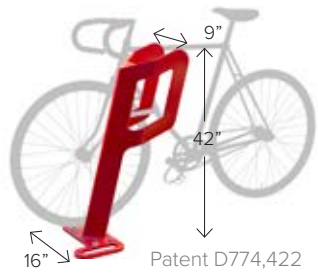

CYCLE DOCK™
 2 🚲 □□□□□

Three points of contact for stability, and lateral spacing to decrease handlebar conflicts.

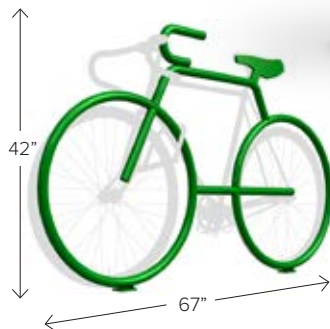

BIKE BIKE RACK

2-4 🚲 □□□□□

An eye-catching, functional piece of street art.





RECYCLE RACKS

2

Made from recycled construction rebar!

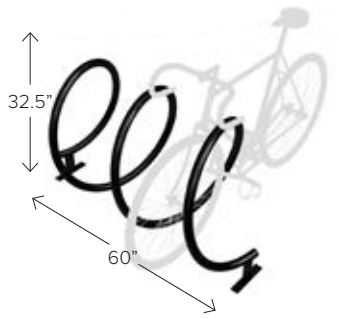

HELIX RACK

6

An attractive, double-sided, space efficient bike rack.

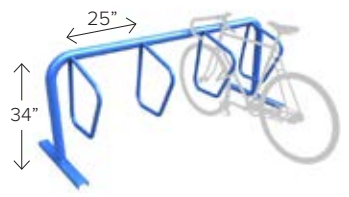

CAMPUS RACK

Supports the frame of the bike while keeping the fork from twisting. The result is convenient, orderly bike parking.

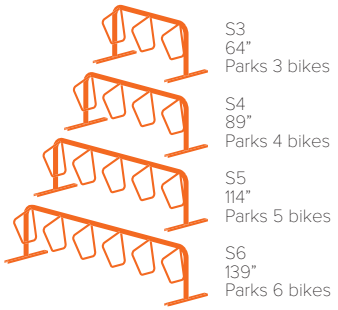

S3
64"
Parks 3 bikes

S4
89"
Parks 4 bikes

S5
114"
Parks 5 bikes

S6
139"
Parks 6 bikes

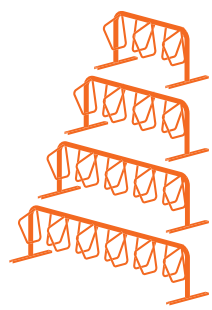

D5
64"
Parks 5 bikes

D7
89"
Parks 7 bikes

D9
114"
Parks 9 bikes

D11
139"
Parks 11 bikes

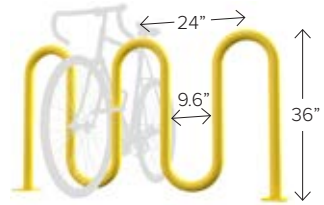

ROLLING RACK
 □□□□□

Space efficient, double-sided bike parking.

- RR2H
38"
5 Bikes
- RR3H
63"
7 Bikes
- RR4H
87"
9 Bikes
- RR5H
111"
11 Bikes

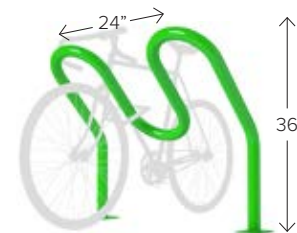

HI ROLLER
 □□□□□

With two points of contact, the Hi Roller provides a greater degree of bicycle support than its purely vertical counterpart.

- Hi2H
42"
4 Bikes
- Hi3H
66"
5 Bikes
- Hi4H
90"
6 Bikes
- Hi5H
114"
7 Bikes



WHAT MAKES A GOOD BIKE RACK?

At a minimum, a good bike rack will allow both the frame and at least one wheel of the bike to be secured with a u-style lock.

For orderly parking, the rack should make at least two points of contact with the bike.

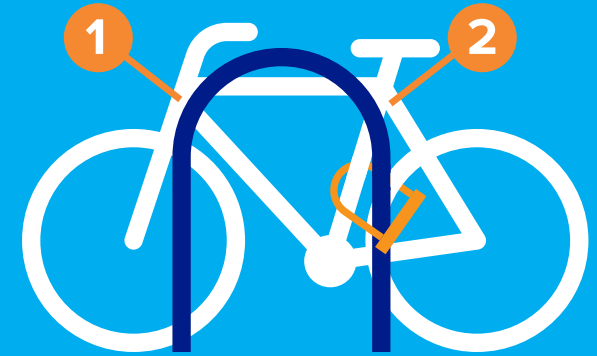

✓ GOOD

There are many examples of good, u-lock compatible bike racks.



✗ BAD

Racks that cradle only the front wheel of the bike should be avoided, since they are not u-lock compatible and may cause damage to bicycles.



Although wave-style racks are u-lock compatible, they do not provide two points of contact with bikes and are not ideal.



CAPACITY AND SPACE USE

These diagrams illustrate the amount of space used by average-sized bikes parked in various ways. Be sure to contact your city government and confirm any applicable minimum ordinances or mandates.

2
Bikes

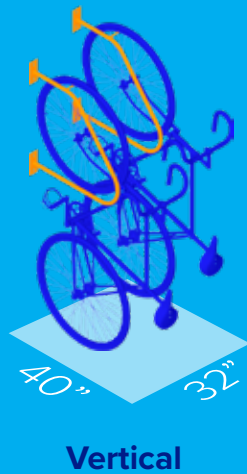
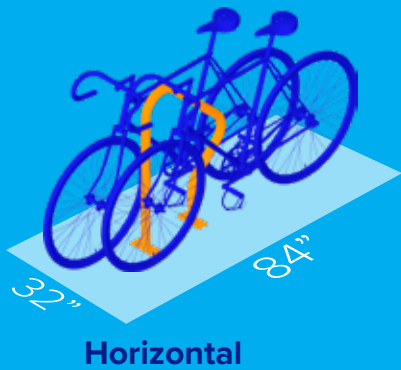

10
Bikes

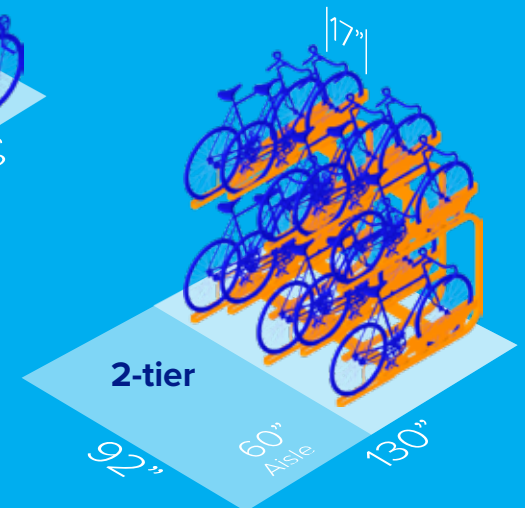
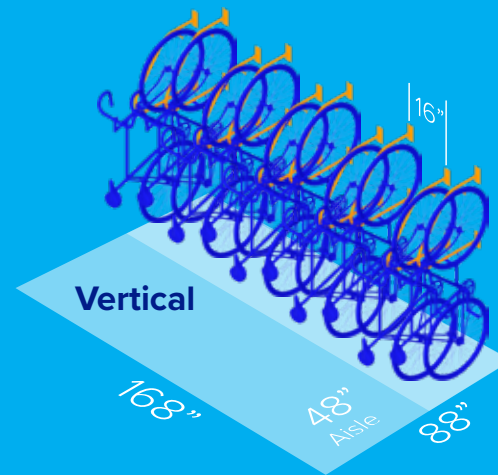
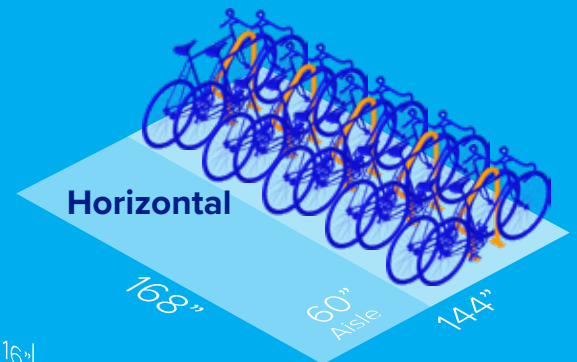



VERTICAL BIKE PARKING

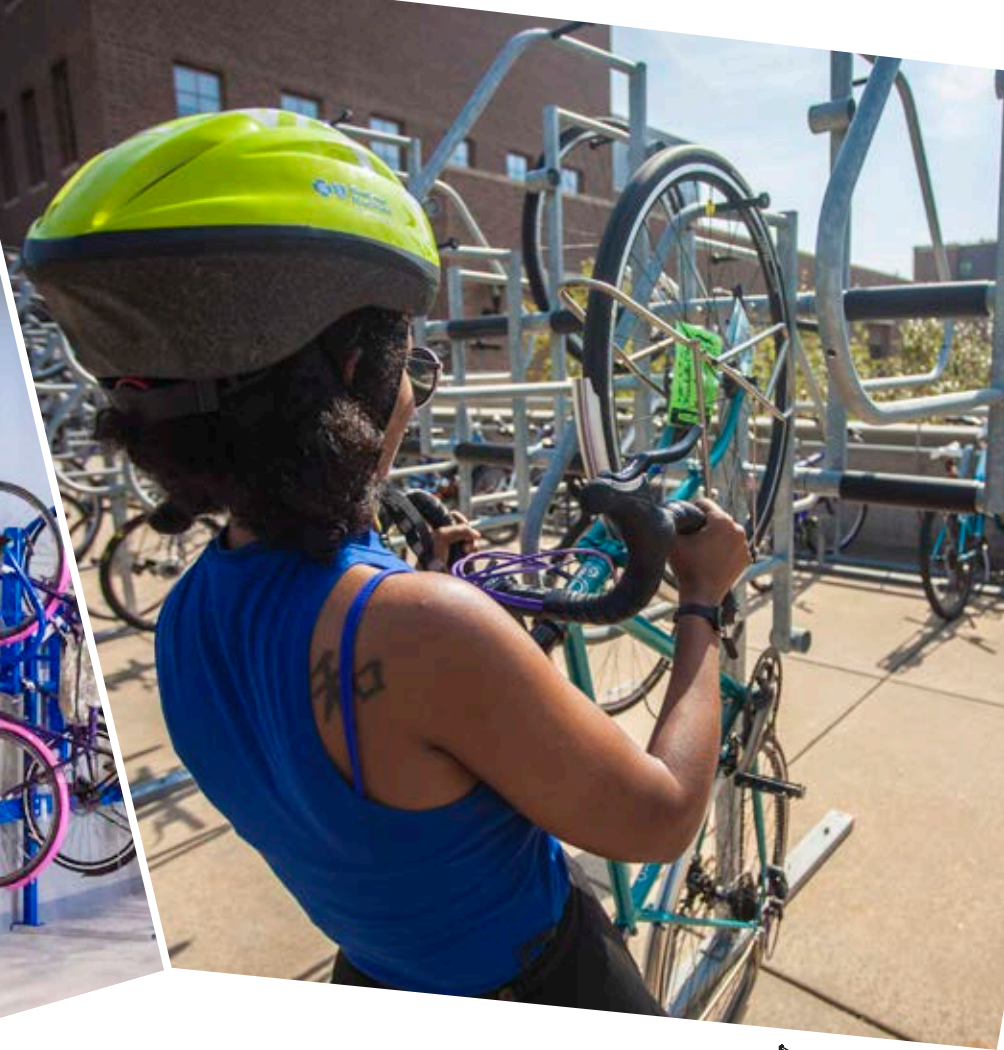

ULTRA SPACE SAVER SQUARED

Adjustable sliding arms make for easy, flexible installation. Square tubing for greater security.

Patent D774,441

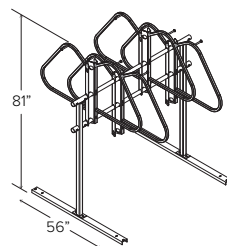
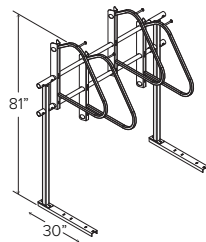

ULTRA SPACE SAVER

A modular system that can be made to fit in nearly any space.

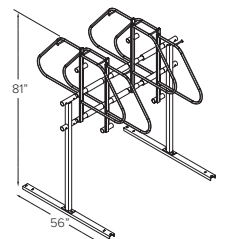
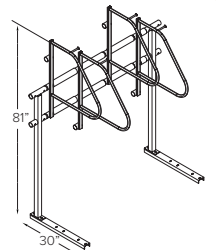

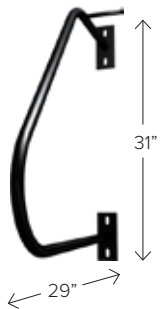
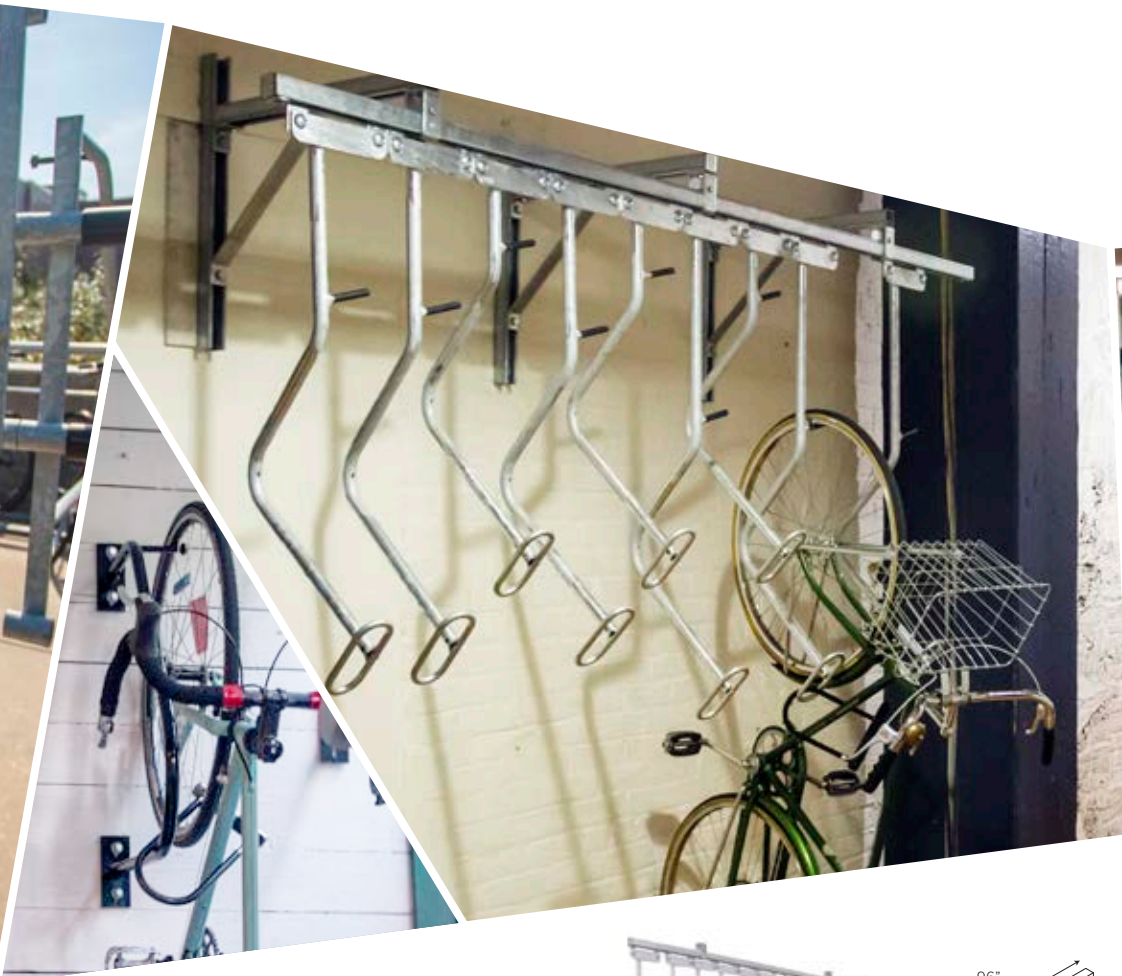

ULTRA SPACE SAVER SINGLE

1

Great for property managers as well for home storage use. Square tube option available.

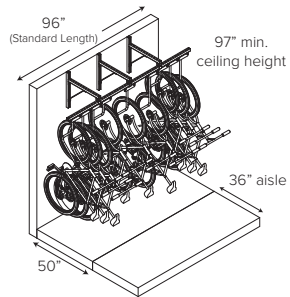

BIKE FILE

9 bikes per 8' section

Sturdy sliding hangers allow 9 bikes to be securely stored in an 8-foot section. U-lock compatible.

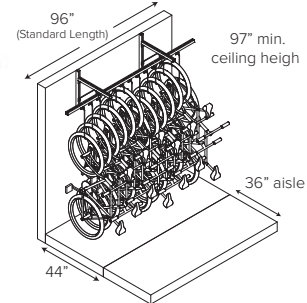

TRACK RACK

13 bikes per 8' section

Staggered, sliding hook design creates the greatest parking efficiency. Not lockable.



2-TIER
PARKING



DERO DECKER

Patent 8,950,592 B1



Unlike other two-tier systems, our lift-assist top trays slide down inches from the ground, thus requiring only minimal lifting of the bike into the tray.



DERO DUPLEX

Patent D768,545



Sturdy trays with high sides keep bikes from slipping off while loading or unloading, and also make the Duplex compatible with most standard u-locks. Minimum 3 sections.



CUSTOM BIKE RACKS

FULL CUSTOM DESIGNS

Create imaginative bike racks that combine aesthetics and high-security parking – or choose from an existing design. Visit www.dero.com to see more custom designed racks.

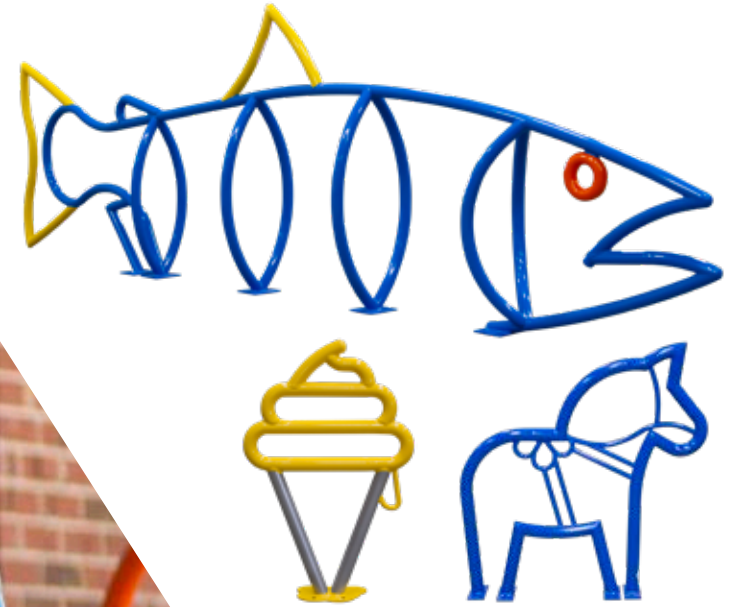



LOGO RACKS

Eye-catching and functional, laser cut logo bike racks create enduring visibility for your brand.



ICON HITCH™

2

Choose from eight designs: beer mug, bike, bird, coffee cup, silverware, maple leaf, music note, and wine glass. Ideal for coffee shops, restaurants, brew pubs, nature centers, and anyone who wishes to make a statement with these eye-catching bike racks.



IMAGE INFUSION

Turn your bike racks into durable, weather-resistant canvases with our unique full-color powder coat process.



TYPE RIDER™ RACKS

2

These laser cut, hand-welded bike racks can be made to spell out a word, brand name, and even a hashtag.



STREETSCAPES





CYCLE STALL BASIC

The Cycle Stall Basic kit covers the needs of cities and businesses that want to provide an on-street bike corral at a low cost and minimal changes to infrastructure.



Choose your style of rack!



CYCLE STALL ELITE

14     

The Cycle Stall Elite's frame is built from rugged, impact resistant, two inch steel. It provides a physical barrier from traffic, while including racks with optimum frame support and security. We can customize this rack with your logo or special shape.



DERO PARKLET

The Dero Parklet is an innovative way to build public gathering spaces right in the heart of the urban streetscape. Businesses and organizations with limited sidewalk space now have the unique ability to extend their atmosphere and aesthetic to the outdoors.

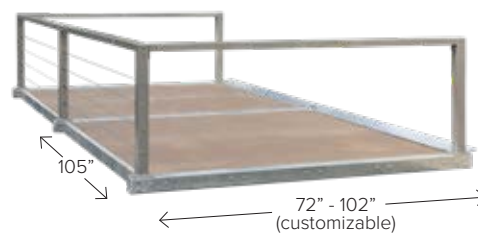

BIKER BAR™

Patent D796,387 S

The Biker Bar™ is a leaning rail designed to give cyclists a place to rest their foot and balance while waiting for the traffic light without having to dismount.



ALL TOGETHER NOW

Combine a variety of Dero solutions to create engaging and attractive amenities for pedestrians and bicyclists in your neighborhoods. You may be surprised what inviting, people-focused sites you can fit into just one or two car parking spaces.



SPECIALTY PRODUCTS



EVENT RACK

14

Patent D583,716

An innovative design that addresses the needs of any game, festival, or event requiring temporary and secure bike parking. Stackable for easy storage.

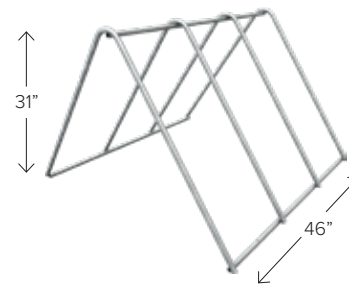

COMPACT RACK

8

Shorter version of the Event Rack with an 8 bike capacity.

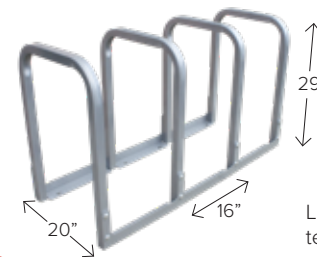

U-LOCKIT™

Patent 9,592,868 B2

Lightweight, modular system for short-term parking at schools, churches, and small businesses. Ships flat.

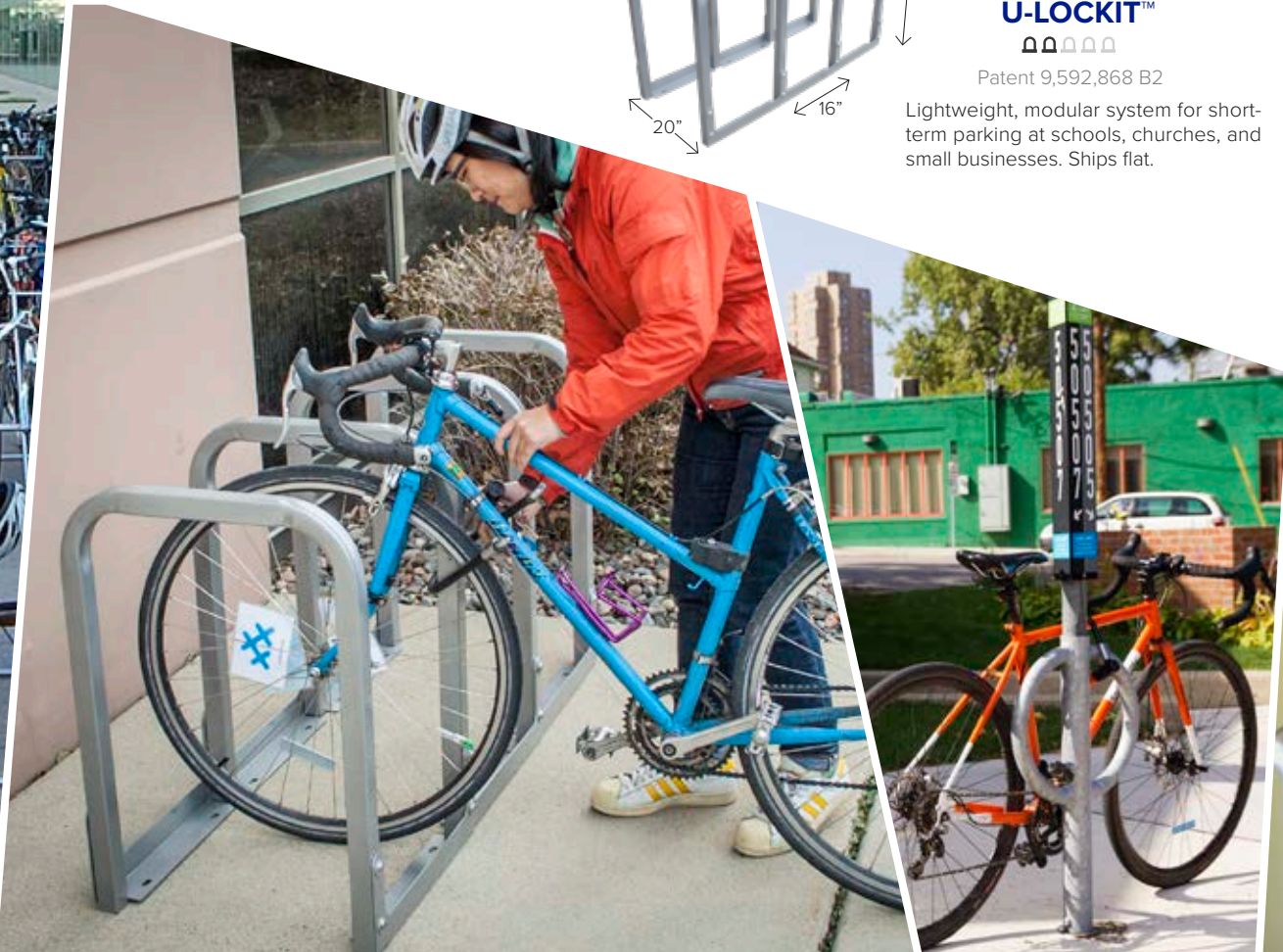



ALLEY RACK™

1-2 □□□□□

Patent D774,423

Arm swings a full 180° to offer a variety of locking positions.

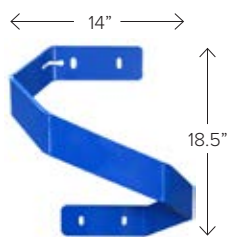

SWITCHBACK™

1 □□□□□

Patent D767,452

Allows for horizontal bike parking along a wall when your space is limited.



SADDLE BUDDY™

Designed for trailheads, bike parks and picnic areas, the Saddle Buddy™ offers a resting place for cyclists' noble steeds. Not a lockable rack.



WALL RACK

2 □□□□□

Rubber coating keeps bikes from getting scratched. U-lock compatible. Ideal for reserved car parking stalls in garages or ramps.



METER HITCH

2 □□□□□

Patent D620,845

Re-uses existing parking meter poles to serve a dual parking purpose.



BIKE HOOK SOLO

1 □□□□□

Provides a simple, space efficient way to store and lock your bike.

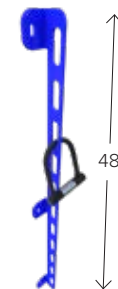

LOCK DOCK

Keeps your commuters' locks readily available.

PUBLIC BIKE REPAIR



Hanger arms accommodate most types of bikes and are ADA compliant

QR code takes smart phone users to comprehensive bike repair videos

Large surface area for sponsorship, branding, or wayfinding signage

Tools are secured with braided stainless steel aircraft cables

All metal pump head accommodates Presta and Schrader valve stem types

Pump holster can be mounted on either side or back of Fixit

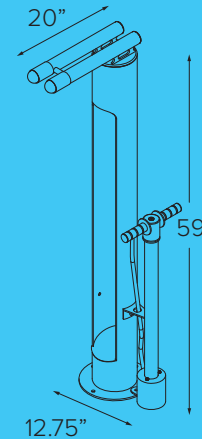

Screwdrivers and Allen Wrenches are on swivel connectors for easier use

Includes most commonly used tools for simple bike maintenance

Pump hose is reinforced for maximum protection

Patents D680,914 and 9,498,880 B2



FIXIT

The Fixit includes all the tools necessary to perform basic bike repairs and maintenance, from changing a flat to adjusting brakes and derailleurs. The tools and air pump are securely attached to the stand with stainless steel cables and tamper-proof fasteners.



Tool Kit and Fixit include the following tools:

- Philips and flat head screwdrivers
- 2.5, 3, 4, 5, 6, 8mm Allen wrenches
- 8, 9, 10, 11, 15, 32mm box wrenches
- Tire levers (2)

Visit www.dero.com/fixitmap/fixitmap.html to see a map of our Fixit stations world-wide.

METAL HEAD

The new Dero Metal Head™ is ready to rock the world of public bicycle repair. Its sturdy cast aluminum construction and easy-to-use functionality takes center stage. Additionally, the new pump head features universal Presta and Schrader valve compatibility.





AIR KIT 2

The Air Kit 2 is a Dero-designed and fabricated bike pump made for public use and built to withstand weather year-round. The Air Kit 2 is built from tough, Schedule 40 steel, and is serviceable down to the plunger and gaskets.

Patent US 9,765,766 B2



AIR KIT 3

The Air Kit 3 is built for outdoor public use. A universal pump head and waterproof PSI gauge are helpful when filling up your bike tires. The pump hose is made of steel-reinforced hydraulic hose for added durability, and replacement pump heads are available on our website.

Patent US 9,765,766 B2



TOOL KIT

All the tools are securely fastened with stainless steel cables and tamper-proof fasteners. Two versions are available – a floor mounted and a wall mounted version.

Patents
D717,214
9,095,973B2
9,505,124B2

PUMP STOP

The Pump Stop holds bikes upright while filling tires with air. It is the perfect accessory to any Dero public air pump.





THINK INSIDE THE BOX WITH BIKE LOCKERS

Bicycle lockers provide the highest level of individual bike security, giving users peace of mind when parking their bike for extended periods. Lockers are increasingly popular at transit hubs due to their modular design and ability to accommodate multimodal transit users.

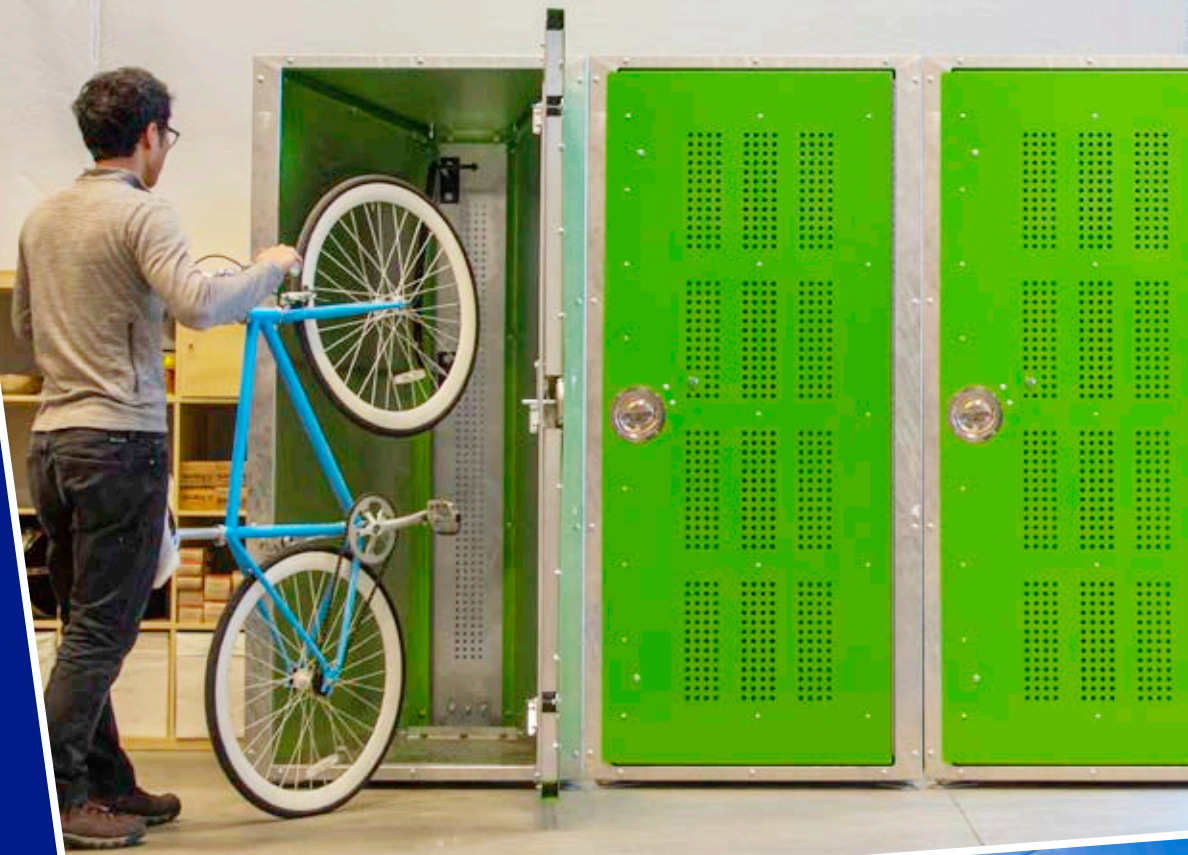

BIKE LOCKERS

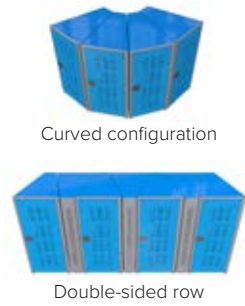
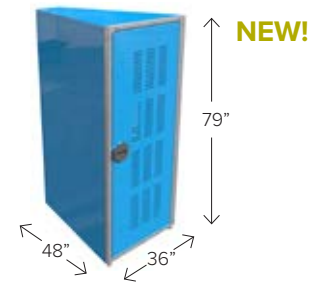

DERO VERTICAL LOCKER

The Dero Vertical Locker unites the space-saving advantages of our Ultra Space Saver parking system with the additional protection of fully-enclosed bike storage. With its unique trapezoidal footprint, the Vertical Locker can be arranged in single or double rows or arcing configurations.

Patent pending



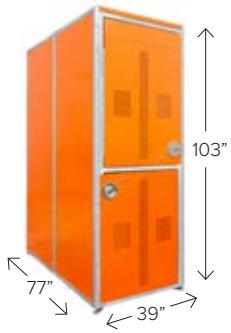

NEW!

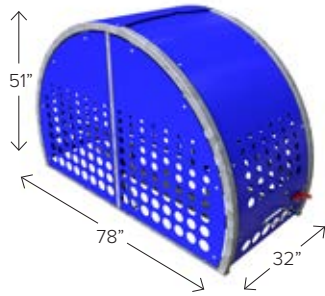

VELOPORT™

The graceful lines and modern laser cut design makes the Veloport™ stand out while offering the security and durability you need in your long-term bike parking. Lift-assist door and lockable inside tray help to guide the bike into the port.

Patent D803,762 S



DERO TWO-TIER LOCKER

We take long-term bicycle storage to new heights with the new Dero Two-Tier Bike Locker. It's upper tray lift-assist makes it easy to load and provides a space-saving solution to meet the increasing demand for covered bike parking.



DERO SINGLE LOCKER™

This steel bike locker is bike security at its best. Ideal for long-term parking, its steel construction makes sure thieves stay out. Multiple locking options and all standard powder coat color options are available. Ships flat to save you money.



DERO DOUBLE LOCKER™

This wider version of our steel bike locker allows the option to store two bikes – with doors at each end and a divider between.



FIBERGLASS LOCKERS

These fiberglass bike lockers come in several sizes. The **300 Series** ships fully assembled, each unit is self contained, two colors are available, and there is a stackable option. The **350 Series** is modular, seven colors are available, includes air vents, stainless steel hardware, gear hooks, number plates, and requires on-site assembly.



BIKE SHELTERS





BIKE DEPOT

The Bike Depot bridges the gap between short and long-term bike parking. An optional wire mesh enclosure provides maximum security for stored bikes. Accommodates 2-tier parking.



ADD LIGHTS FOR ADDITIONAL SECURITY

Dero now offers bright, solar powered lighting units for most of our bike shelters. Ask a sales representative for more details.



VIZOR™ SHELTER

A simple, elegant cantilevered bicycle shelter.

Patent D748,562



CYCLE STATION

With a high roof and open platform, the Dero Cycle Station accepts bike corrals, vertical, or two-tiered bike racks configured to meet your specific needs. Additional options like enclosures and lighting are available.





STRATUS SHELTER™

The Stratus Shelter™ is a striking bike shelter option for any transit station, university campus, or multi-family residential building project. It is constructed of American-made, galvanized steel, and clear, tempered, laminated glass roof panels and optional side panels.

Patent Pending



POCKET SHELTER

Small and versatile, the Pocket Shelter stores bikes in areas that would not normally accommodate bike parking. This shelter is a modular system that provides covered and secure bike storage but is extremely space efficient and cost-effective.



KOLO SHELTER

The unique styling of our Dero Kolo Shelter will help beautify your facility and provide secure, covered bike parking for cyclists.





Free CAD Layouts

Let us maximize your bike parking. Send us a drawing of your space and our expert CAD trained staff will provide you with a free layout that gets the most out of your available room – at no charge.



Installation

Got a big project you want installed right? Dero can provide installation service anywhere in the United States. Subject to minimum order size.



Free Custom Designs

Got an idea for a great artistic bike rack? Send us a description or sketch and we will send back a free mockup of your design. The possibilities are endless.

STANDARD PRODUCT OPTIONS

FINISH OPTIONS



Galvanized

Hot-dipped galvanized is an extremely durable and low-cost finish option. The bike racks are hot-dipped galvanized after fabrication and then hand ground to ensure a clean, safe surface.



Stainless

Stainless steel is the most beautiful and durable option. We use a 304 grade stainless steel which will continue to look new and attractive for many years. Satin finish is standard.



PVC Dip

Galvanization is applied before being dipped in UV-stabilized PVC. The coating is subsequently cured to produce a coating that offers excellent protection against abrasion, impact, and corrosion.

Powder Coat

Powder coating provides a durable finish using a solvent-free process that is better for the environment than liquid paints. We offer 20 standard colors and can special order from over 250 custom colors.



MOUNT OPTIONS

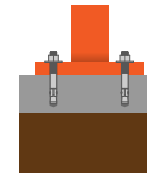

Surface

Metal flange anchors to the ground with included wedge anchors. Other special anchors such as tamper-proof nuts are also available.



In-Ground

Rack is embedded into concrete surface.



Rail

Racks are bolted to rails which may be anchored to surface or left freestanding.

Tamper-resistant Fasteners



Breakaway Nut



Stainless Tamper-Proof Nut



Triple-Slot Nut



Concrete Spike

DERO ZAP

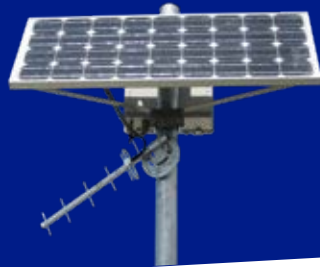

AUTOMATED COMMUTER TRACKING SYSTEM

Patents #8,876,009 B2 #8,952,786 #9,715,610 B2



A tamper-proof RFID tag attaches to the front wheel of each registered bike. Hand-held tags are available for people who walk to work.



A ZAP station detects tags as they pass by.



Our powerful web app reports on the data received from each station.

MORE BIKING AND WALKING

Dero ZAP encourages people to bike or walk more and stick with it. Since it's automatic, participants simply have to walk or bike past a ZAP sensor to receive wellness points, prizes or discounts from your wellness program.

SAVE TIME

Dero ZAP automates the management of your commuter program. No more manual entry of commutes; all the data you need is available online or as an easy download.

SAVE MONEY

A modest amount of exercise every day helps prevent painful and expensive medical problems. Keep your employees fit and productive while lowering overall health care costs.

Learn more at www.derozap.com



SITE AMENITIES

BY **ultra site**

A PLACORE Company

Dero offers a selection of site amenities by our sister company UltraSite. They have over 25 years of experience providing excellent park furnishings and site amenities. Choose from a wide variety of items, such as benches, bollards, and trash receptacles. These products will provide any public space with a functional blend of creative design and security – perfect for parks and rec and indoor bike rooms.



DERO
A PLAYCORE Company

WE KNOW BIKE PARKING.
INSIDE AND OUT.®

42 Northern Stacks Drive
Suite 100
Minneapolis, MN 55421



**BEN
SHAFFER
RECREATION**

973-663-2021 www.benshaffer.com